

200V PNP MEDIUM POWER HIGH GAIN TRANSISTOR IN E-LINE

Features

- $BV_{CEO} > -200V$
- $I_C = -0.5A$ High Continuous Collector Current
- $I_{CM} = -1A$ Peak Pulse Current
- T_J up to $200^{\circ}C$ for High Temperature Operation
- $h_{FE} > 250 @ 0.3A$ for High Gain Hold-Up
- $P_D = 1W$ Power dissipation
- Complementary NPN Type: ZTX696B
- **Totally Lead-Free & Fully RoHS compliant (Notes 1 & 2)**
- **Halogen and Antimony Free. "Green" Device (Note 3)**
- **Qualified to AEC-Q101 Standards for High Reliability**

Mechanical Data

- Case: E-Line (TO-92 Compatible)
- Case Material: molded plastic, "Green" Molding Compound
- UL Flammability Classification Rating 94V-0
- Terminals: Finish – Matte Tin Plated Leads, Solderable per MIL-STD-202, Method 208 
- Weight: 0.159 grams (approximate)

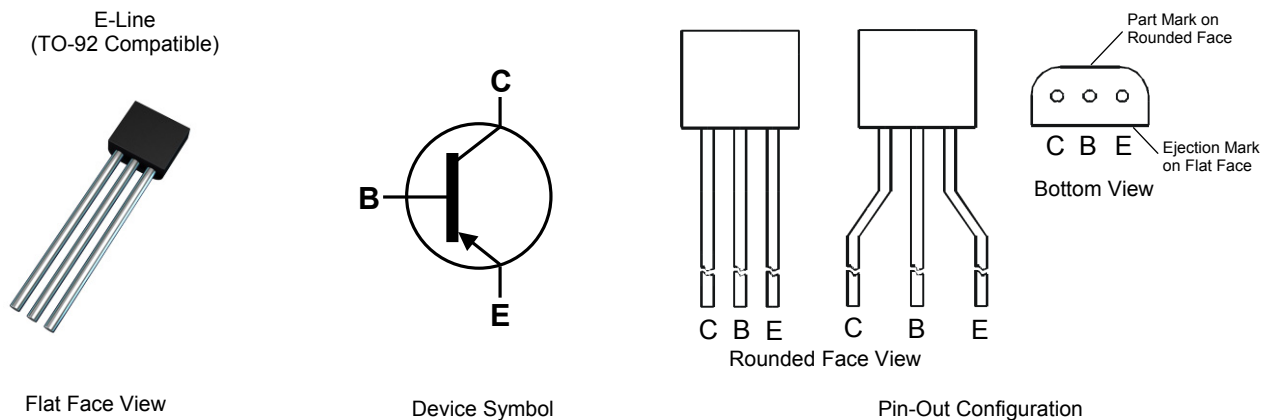

Ordering Information (Note 4)

Product	Marking	Package	Leads	Quantity
ZTX796ASTZ	ZTX796A	E-Line	Joggled	2,000 Taped per Ammo Box
ZTX796A	ZTX796A	E-Line	Straight	4,000 Loose in a Box

- Notes:
1. No purposely added lead. Fully EU Directive 2002/95/EC (RoHS) & 2011/65/EU (RoHS 2) compliant.
 2. See http://www.diodes.com/quality/lead_free.html for more information about Diodes Incorporated's definitions of Halogen- and Antimony-free, "Green" and Lead-free.
 3. Halogen- and Antimony-free "Green" products are defined as those which contain <900ppm bromine, <900ppm chlorine (<1500ppm total Br + Cl) and <1000ppm antimony compounds.
 4. For packaging details, go to our website at <http://www.diodes.com/products/packages.html>.

Marking Information

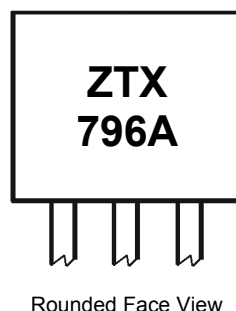

ZTX796A = Product Type Marking Code

Maximum Ratings (@ $T_A = +25^\circ\text{C}$, unless otherwise specified.)

Characteristic	Symbol	Value	Unit
Collector-Base Voltage	V_{CBO}	-200	V
Collector-Emitter Voltage	V_{CEO}	-200	V
Emitter-Base Voltage	V_{EBO}	-5	V
Continuous Collector Current	I_C	-0.5	A
Peak Pulse Current	I_{CM}	-1	A

Thermal Characteristics (@ $T_A = +25^\circ\text{C}$, unless otherwise specified.)

Characteristic	Symbol	Value	Unit
Power Dissipation (Note 5)	P_D	1.5	W
Power Dissipation (Note 6)	P_D	1	W
Thermal Resistance Junction to Ambient (Note 5)	$R_{\theta JA}$	116	$^\circ\text{C}/\text{W}$
Thermal Resistance Junction to Ambient (Note 6)	$R_{\theta JA}$	175	$^\circ\text{C}/\text{W}$
Thermal Resistance Junction to Lead (Note 7)	$R_{\theta JL}$	70	$^\circ\text{C}/\text{W}$
Operating and Storage Temperature Range	T_J, T_{STG}	-55 to +200	$^\circ\text{C}$

- Notes:
5. For a through-hole device mounted at the seating plane (2.5mm lead length) with the collector lead on 25mm x 25mm 1oz copper that is on a single-sided FR4 PCB; device is measured under still air conditions whilst operating in a steady-state.
 6. Same as note (5), except the device is mounted on minimum recommended pad layout with 12mm lead length from the bottom of package to the board.
 7. Thermal resistance from junction to solder-point at the seating plane (2.5mm from the bottom of package along the collector lead).

Thermal Characteristics and Derating Information

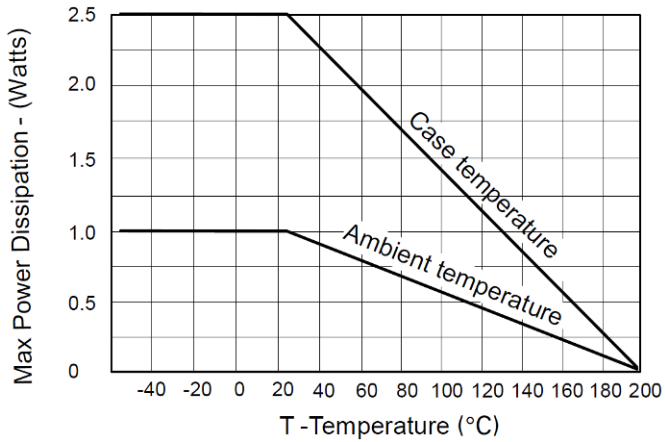
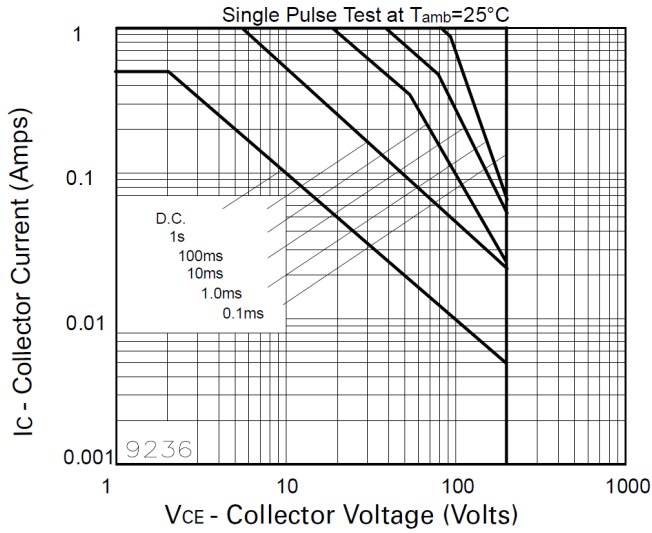

Derating curve

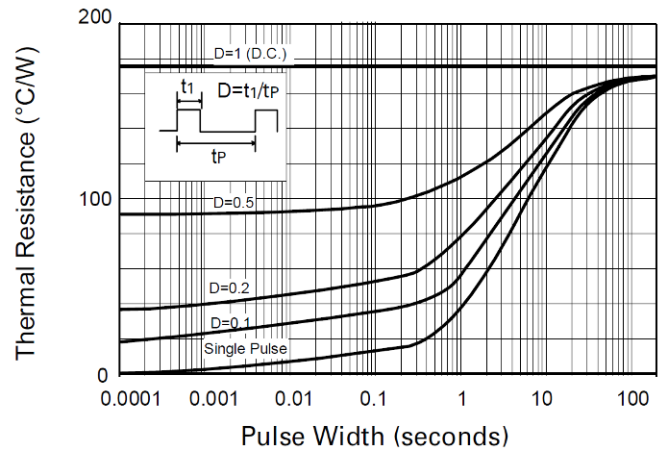

Maximum transient thermal impedance

Electrical Characteristics (@T_A = +25°C, unless otherwise specified.)

Characteristic	Symbol	Min	Typ	Max	Unit	Test Condition
Collector-Base Breakdown Voltage	BV _{CB0}	-200	—	—	V	I _C = -100μA
Collector-Emitter Breakdown Voltage (Note 7)	BV _{CEO}	-200	—	—	V	I _C = -1mA
Emitter-Base Breakdown Voltage	BV _{EBO}	-5	—	—	V	I _E = -100μA
Collector-Emitter Cutoff Current	I _{CES}	—	—	-0.1	μA	V _{CE} = -150V
Collector-Base Cutoff Current	I _{CB0}	—	—	-0.1	μA	V _{CB} = -150V
Emitter-Base Cutoff Current	I _{EBO}	—	—	-0.1	μA	V _{EB} = -4V
Collector-Emitter Saturation Voltage (Note 7)	V _{CE(sat)}	—	—	-0.2	mV	I _C = -50mA, I _B = -2mA
		—	—	-0.3	mV	I _C = -100mA, I _B = -5mA
		—	—	-0.3	mV	I _C = -200mA, I _B = -20mA
Base-Emitter Saturation Voltage (Note 7)	V _{BE(sat)}	—	—	-0.95	mV	I _C = -200mA, I _B = -20mA
Base-Emitter Turn-On Voltage (Note 7)	V _{BE(on)}	—	-0.67	—	mV	I _C = -200mA, V _{CE} = -10V
Static Forward Current Transfer Ratio (Note 7)	h _{FE}	300	—	800	—	I _C = -10mA, V _{CE} = -10V
		300	—	—	—	I _C = -100mA, V _{CE} = -10V
		250	—	—	—	I _C = -300mA, V _{CE} = -10V
		100	—	—	—	I _C = -400mA, V _{CE} = -10V
Transition Frequency	f _T	100	—	—	MHz	V _{CE} = -5V, I _C = -50mA f = 50MHz
Input Capacitance	C _{ibo}	—	225	—	pF	V _{EB} = -0.5V, f = 1MHz
Output Capacitance	C _{obo}	—	12	—	pF	V _{CB} = -10V, f = 1MHz
Switching Times	t _{on}	—	100	—	ns	V _{CC} = -50V, I _C = -100mA
	t _{off}	—	3200	—	ns	I _{B1} = -I _{B2} = -10mA

Note: 7. Measured under pulsed conditions. Pulse width ≤ 300 μs. Duty cycle ≤ 2%

Typical Electrical Characteristics (@T_A = +25°C, unless otherwise specified.)

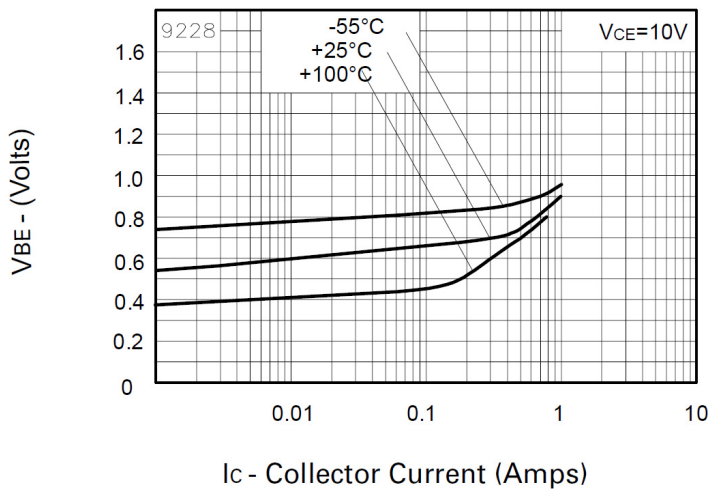
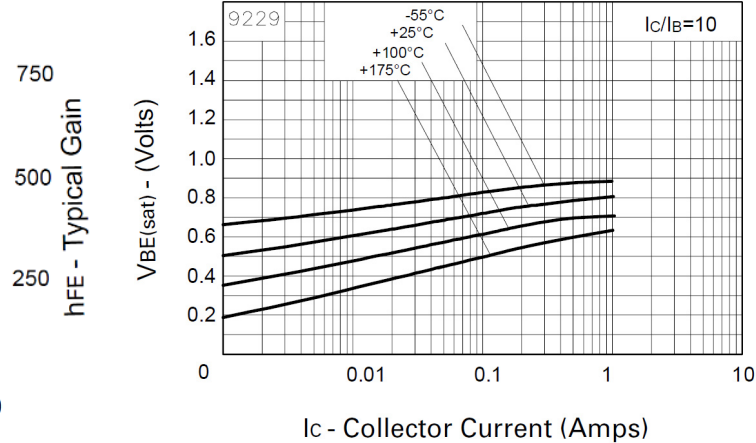
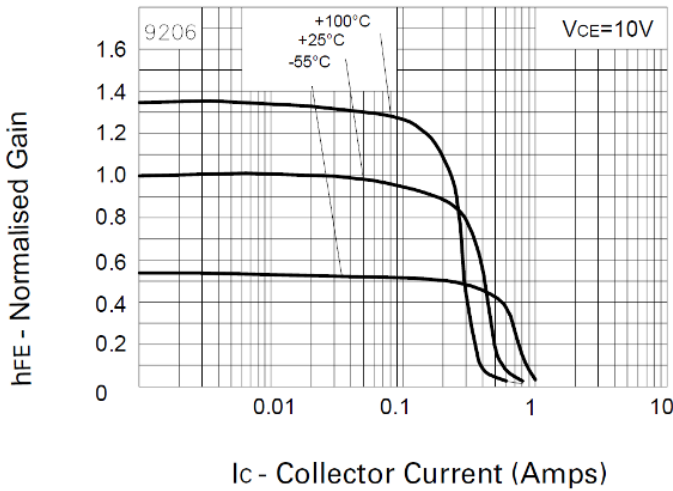
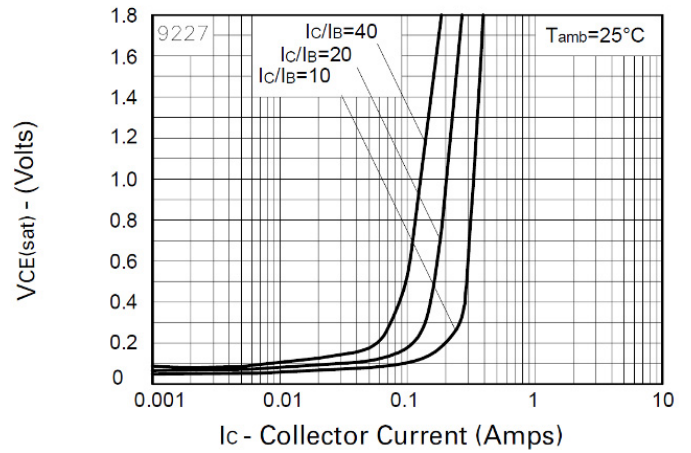
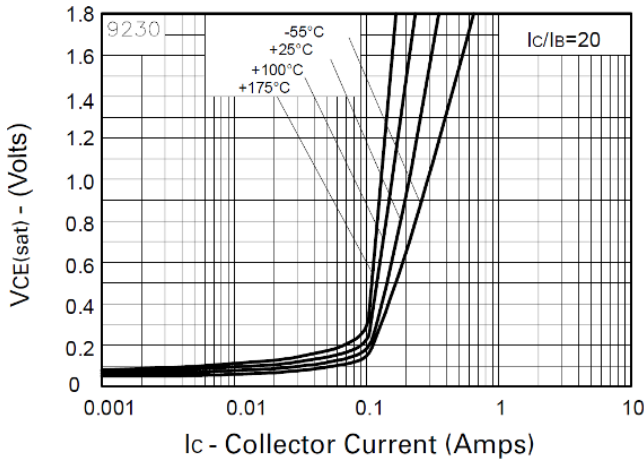

Package Outline Dimensions

Please see AP02002 at <http://www.diodes.com/datasheets/ap02002.pdf> for latest version.

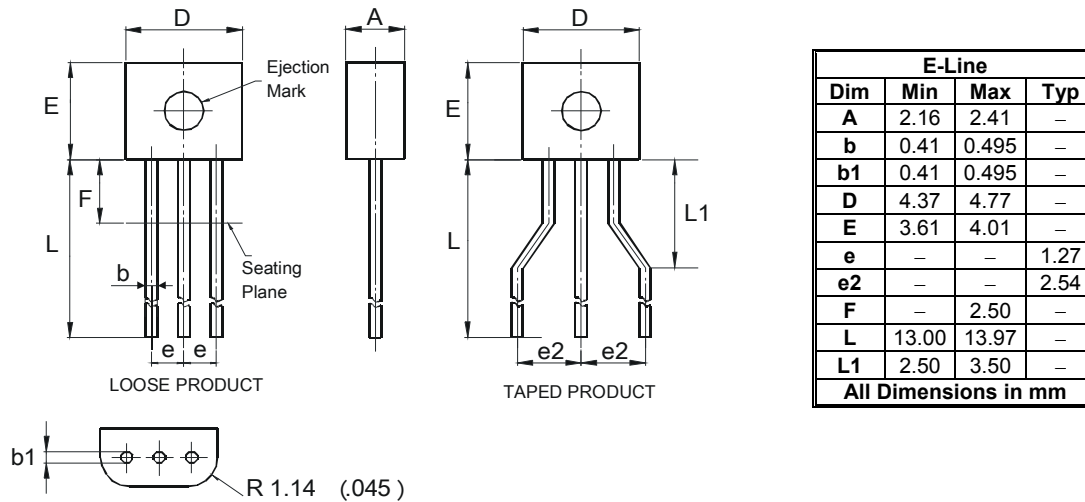

Note: For high voltage applications, the appropriate industry sector guidelines should be considered with regards to voltage spacing between terminals.

IMPORTANT NOTICE

DIODES INCORPORATED MAKES NO WARRANTY OF ANY KIND, EXPRESS OR IMPLIED, WITH REGARDS TO THIS DOCUMENT, INCLUDING, BUT NOT LIMITED TO, THE IMPLIED WARRANTIES OF MERCHANTABILITY AND FITNESS FOR A PARTICULAR PURPOSE (AND THEIR EQUIVALENTS UNDER THE LAWS OF ANY JURISDICTION).

Diodes Incorporated and its subsidiaries reserve the right to make modifications, enhancements, improvements, corrections or other changes without further notice to this document and any product described herein. Diodes Incorporated does not assume any liability arising out of the application or use of this document or any product described herein; neither does Diodes Incorporated convey any license under its patent or trademark rights, nor the rights of others. Any Customer or user of this document or products described herein in such applications shall assume all risks of such use and will agree to hold Diodes Incorporated and all the companies whose products are represented on Diodes Incorporated website, harmless against all damages.

Diodes Incorporated does not warrant or accept any liability whatsoever in respect of any products purchased through unauthorized sales channel. Should Customers purchase or use Diodes Incorporated products for any unintended or unauthorized application, Customers shall indemnify and hold Diodes Incorporated and its representatives harmless against all claims, damages, expenses, and attorney fees arising out of, directly or indirectly, any claim of personal injury or death associated with such unintended or unauthorized application.

Products described herein may be covered by one or more United States, international or foreign patents pending. Product names and markings noted herein may also be covered by one or more United States, international or foreign trademarks.

This document is written in English but may be translated into multiple languages for reference. Only the English version of this document is the final and determinative format released by Diodes Incorporated.

LIFE SUPPORT

Diodes Incorporated products are specifically not authorized for use as critical components in life support devices or systems without the express written approval of the Chief Executive Officer of Diodes Incorporated. As used herein:

A. Life support devices or systems are devices or systems which:

1. are intended to implant into the body, or
2. support or sustain life and whose failure to perform when properly used in accordance with instructions for use provided in the labeling can be reasonably expected to result in significant injury to the user.

B. A critical component is any component in a life support device or system whose failure to perform can be reasonably expected to cause the failure of the life support device or to affect its safety or effectiveness.

Customers represent that they have all necessary expertise in the safety and regulatory ramifications of their life support devices or systems, and acknowledge and agree that they are solely responsible for all legal, regulatory and safety-related requirements concerning their products and any use of Diodes Incorporated products in such safety-critical, life support devices or systems, notwithstanding any devices- or systems-related information or support that may be provided by Diodes Incorporated. Further, Customers must fully indemnify Diodes Incorporated and its representatives against any damages arising out of the use of Diodes Incorporated products in such safety-critical, life support devices or systems.

Copyright © 2013, Diodes Incorporated

www.diodes.com

Mouser Electronics

Authorized Distributor

Click to View Pricing, Inventory, Delivery & Lifecycle Information:

[Diodes Incorporated:](#)

[ZTX796A](#)